

Exemple de système de închidere Dorma - manuale sau automate

SISTEME DORMA UNIVERSAL

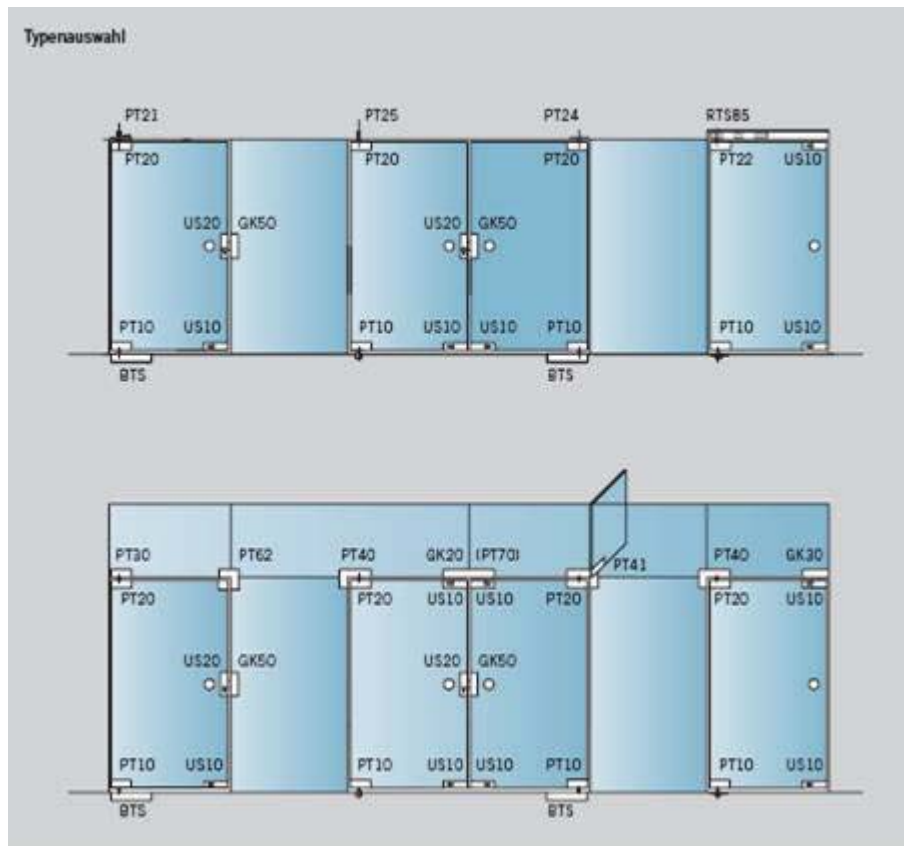

Typenauswahl

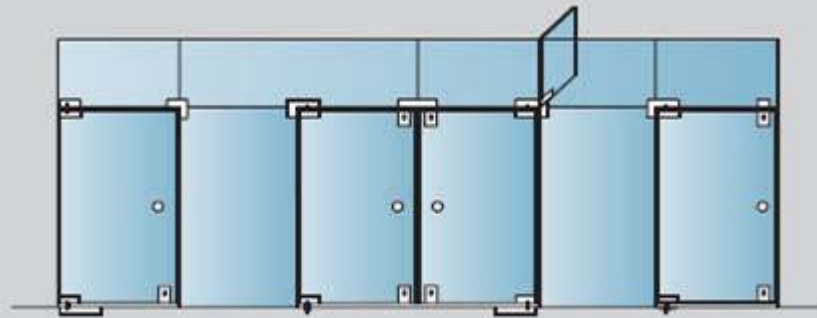
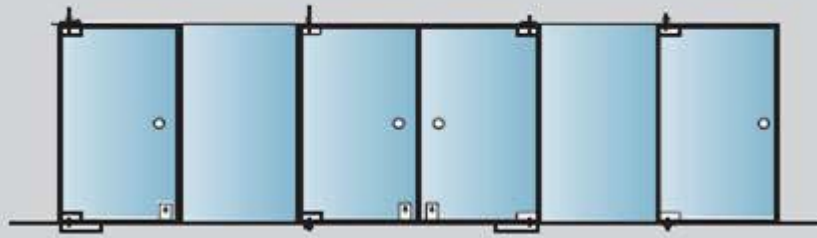

Anlagen-Beispiel

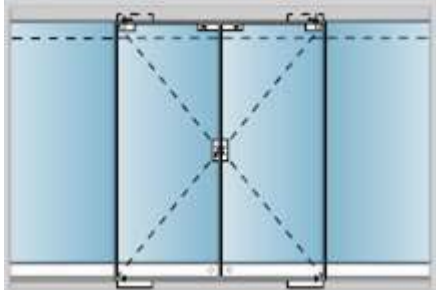

Anschlagtüren in Ganzglas-Anlage

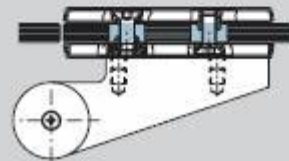
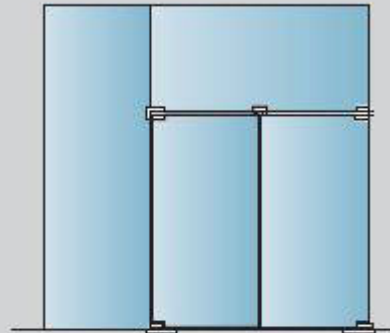

DORMA Universal Eck-, Mittelschlösser und Gegenkästen für Glasausschnitte

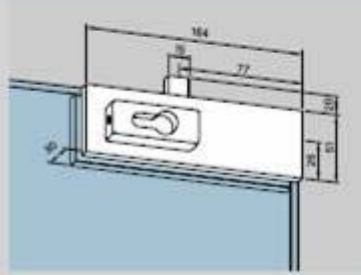
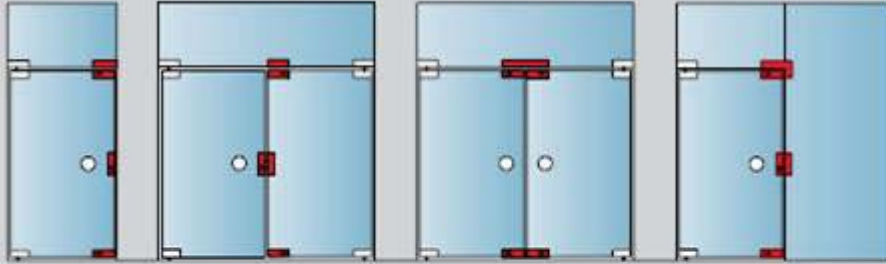

Beispiel Universal-Eckschloss für Glasausschnitt

Eck-, Mittelschlösser und Gegenkästen für Bohrungen

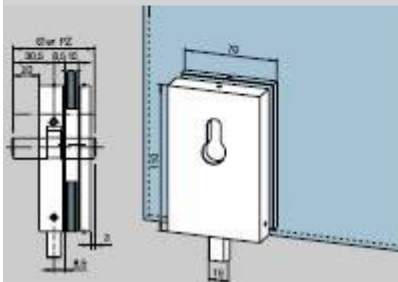
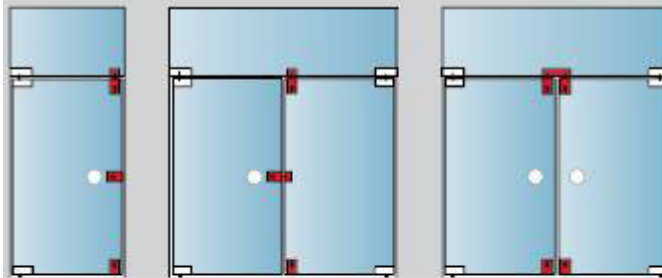

Beispiel Eckschloss

SISTEM DORMA ARCOS

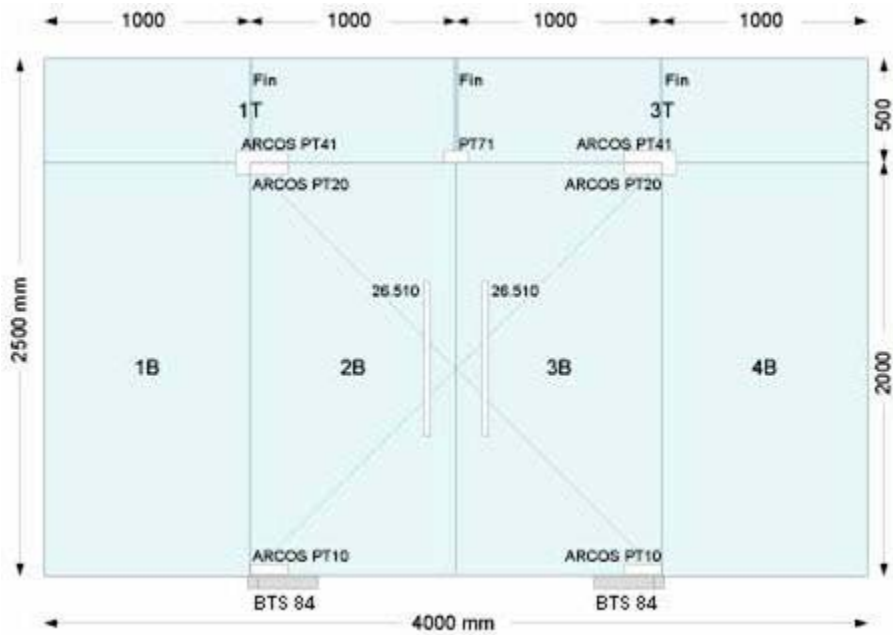

Viewed from outside

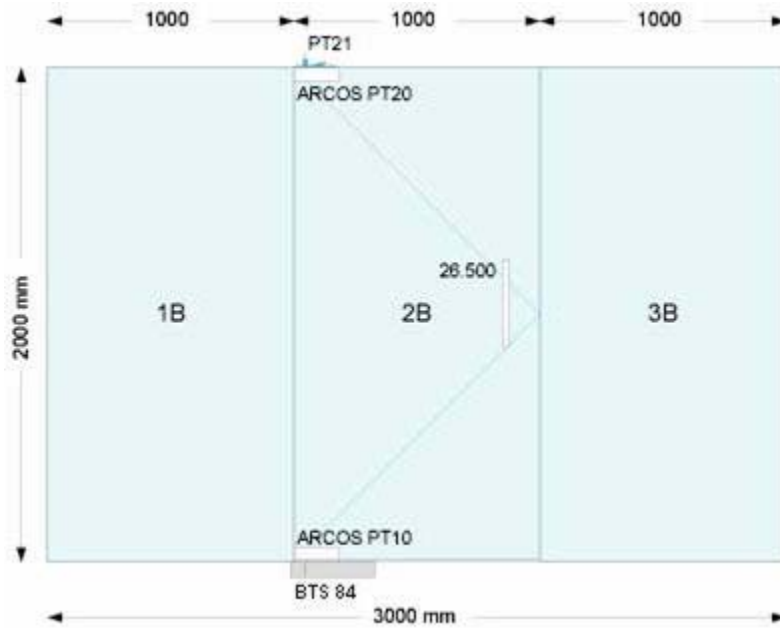

Viewed from outside

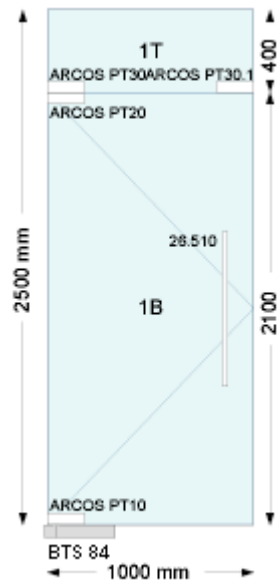

Viewed from outside

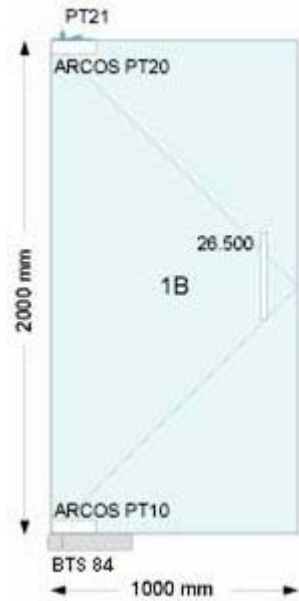

Viewed from outside

SISTEM DORMA BEYOND

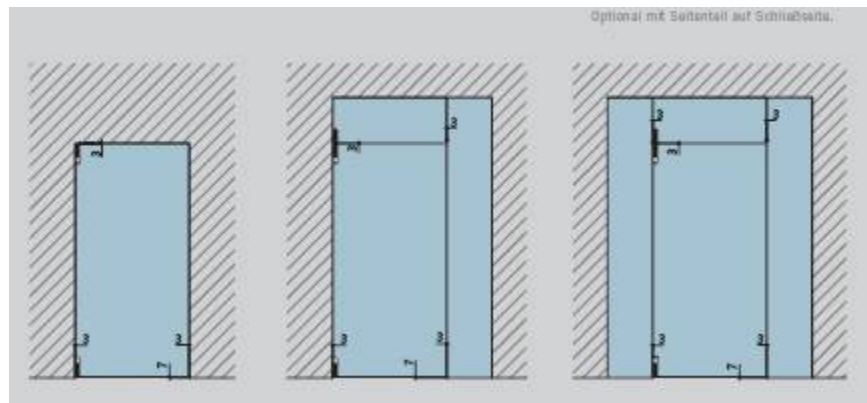

SISTEM DORMA AGILE

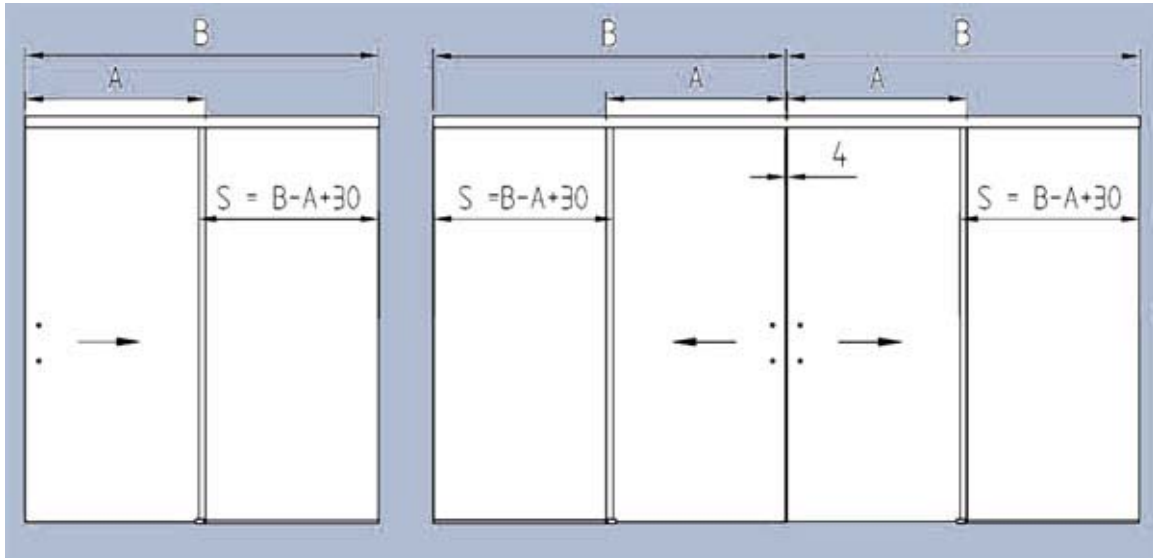

SISTEM USA CULISANTA CU SUPRALUMINA

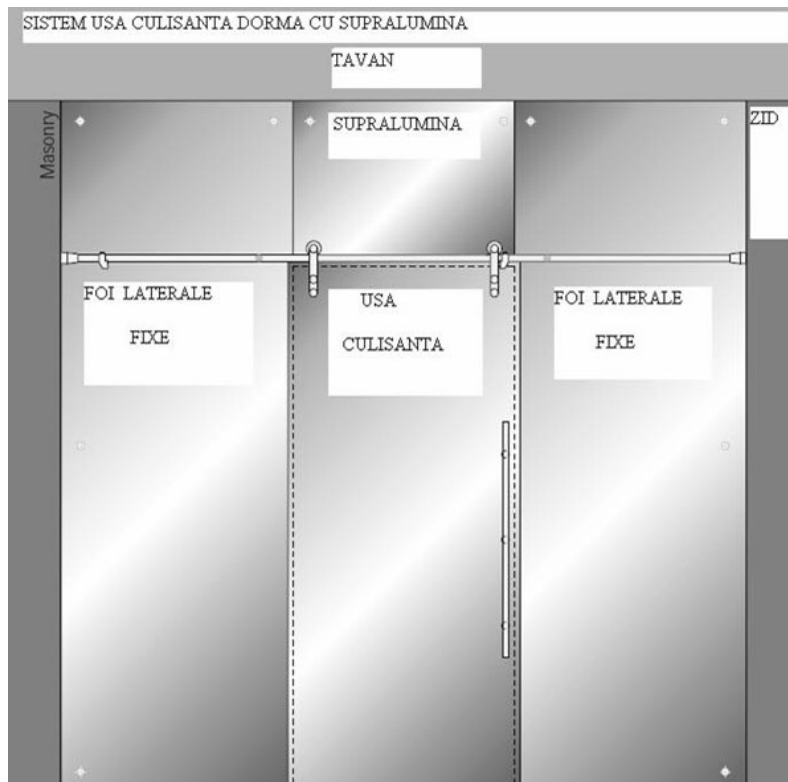

SISTEM HSW

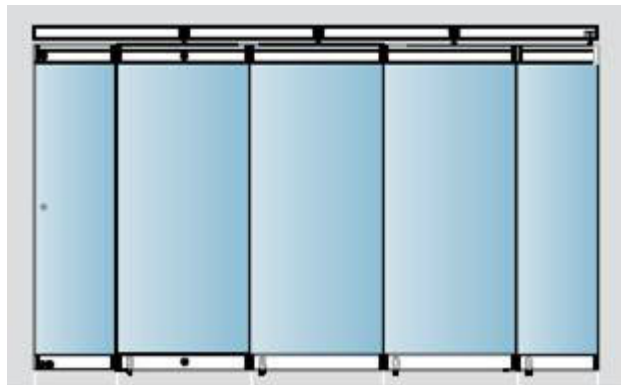
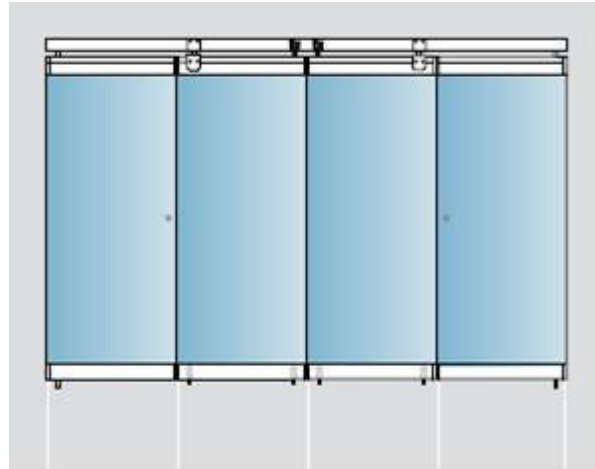
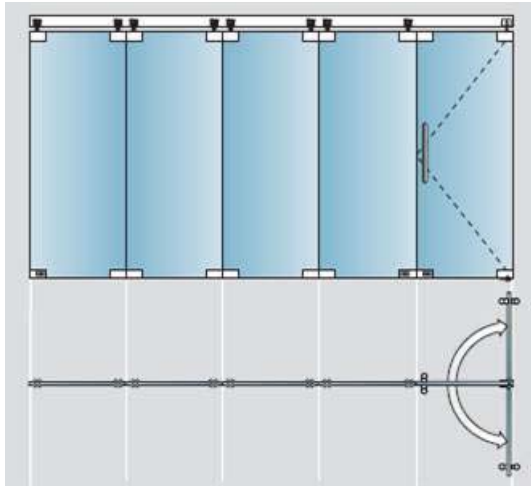
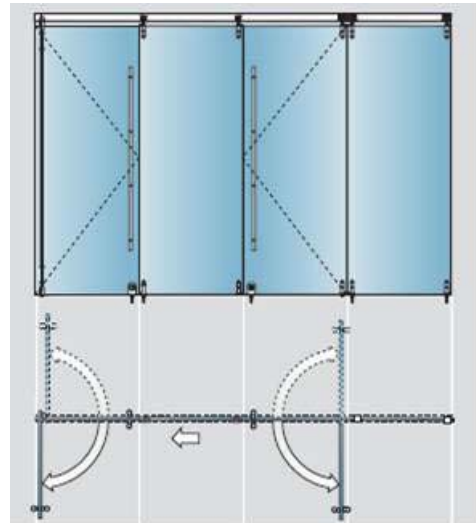
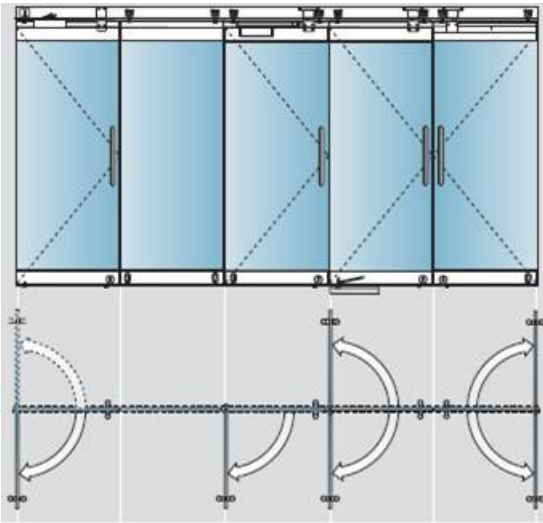



HSW-ARCOS
Flügel mit oberen und unteren ARCOS-Türschielen und freier seitlicher Glaskante



HSW-G
Flügel mit oberen und unteren Türschielen und freier seitlicher Glaskante



HSW-GP
Flügel mit MANET-Punktbeschlägen



HSW-GE
Flügel mit Eckbeschlägen

SISTEME AUTOMATE DORMA

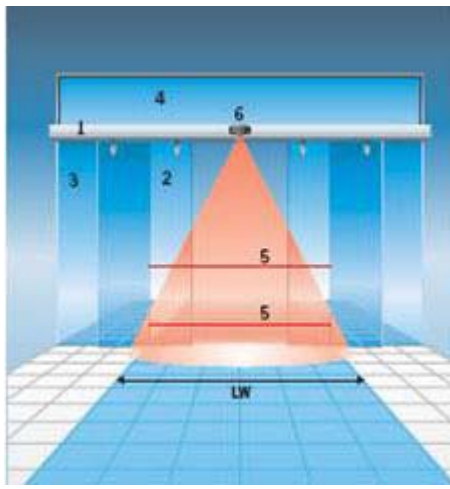
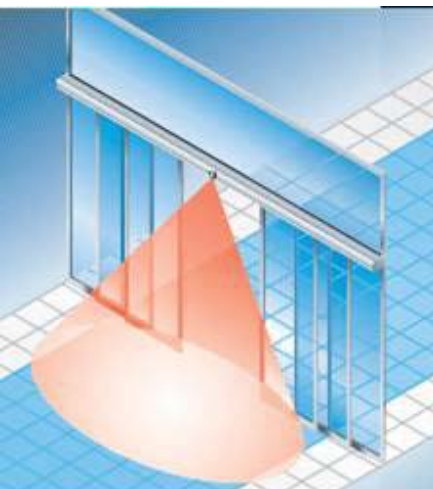
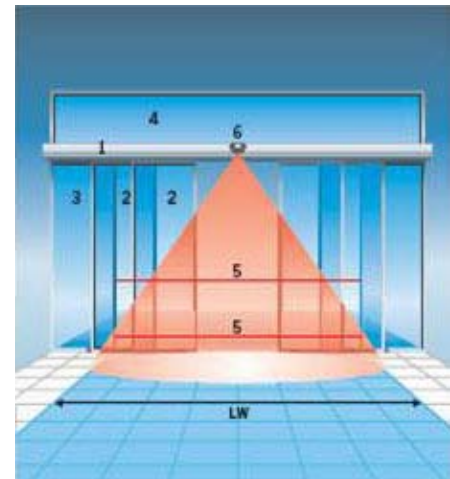
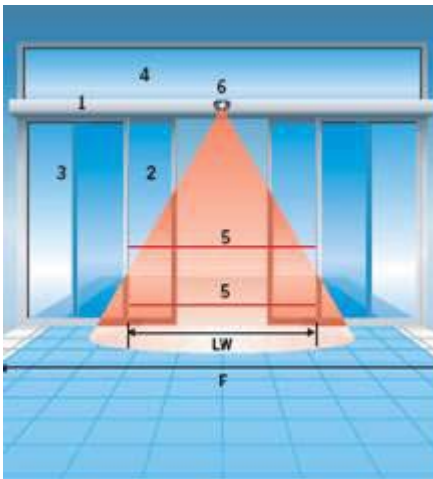
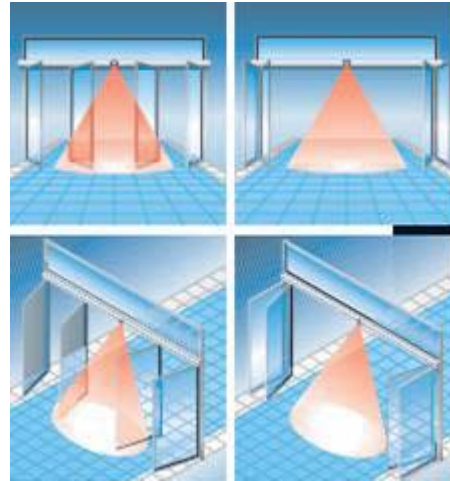

DORMA

CS-EC2



WIN 055783
07/02

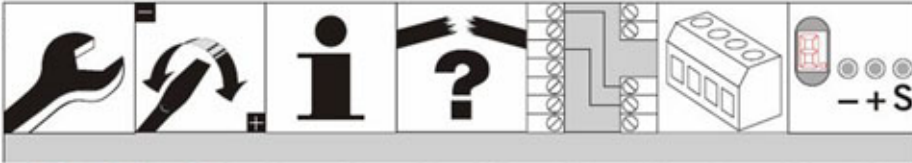

D **GB** **F** I NL DK S N FIN E P PL





(D) (GB) (F) (I) (NL) (DK) (S) (N) (FIN) (E) (P) (PL)

